

Varenummer: 03445110  
Beskrivelse: Fluro Heavy Duty Ledleje GE 110 EW-2RS  
Hul Ø110  
Note: 110

## Mål

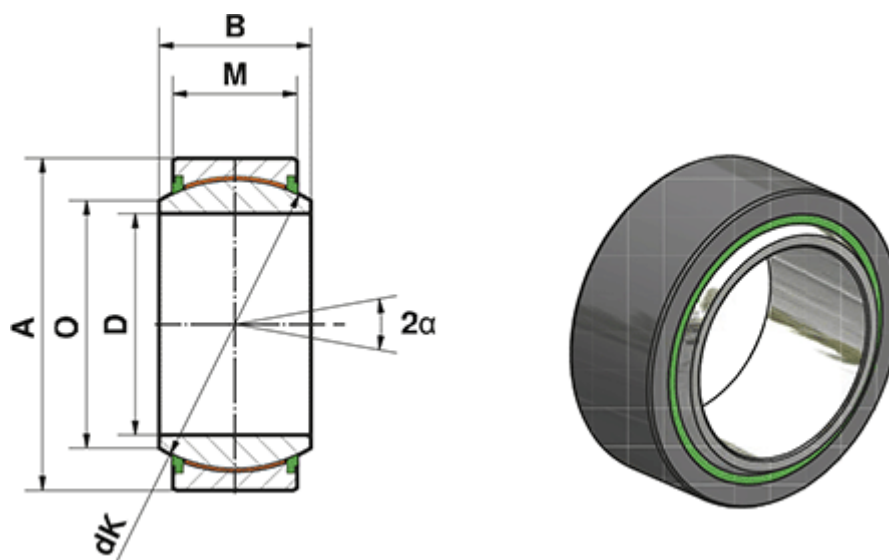

A	= 160
a (grader)	= 6
B	= 70
D	= 110
dK	= 140
Dynamisk belastning C (kN)	= 1845
M	= 55
O	= 121.2

Statisk belastning C0 (kN)	= 3075
Vægt (g)	= 4700